

# NPE-A2 and NPE-S2 Condensing Tankless Water Heaters

The best selling  
high-efficiency  
condensing  
tankless water  
heaters in  
North America



Innovative advancements in the NPE-2  
condensing tankless water heaters make  
it easier than ever to go tankless.

# NPE-2 PREMIUM EFFICIENCY CONDENSING TANKLESS WATER HEATERS

Navien...the proven leader in condensing tankless, makes it even easier to sell, install and set up with new NPE-2 series

## Cuts installation time in half

Thanks to using 1/2" gas pipe and 2" PVC venting, you can install a Navien tankless water heater in about half the time as competitive tankless heaters. Not to mention, Navien EZNav™ intuitive controls with setup wizard makes startup a simple and fast process.

## Fewer callbacks, longer life, faster heating

Navien was first to offer dual stainless steel heat exchangers which helps extend the life of the unit by resisting corrosion.

## Saves energy, easier on the planet

Navien condensing stainless steel heat exchangers recover extra heat that would be lost in non-condensing units. Lower CO<sub>2</sub> emissions and low exhaust temperatures allows for less expensive venting materials like schedule 40 PVC.



## NPE-2 temperature rise

Temp Rise (°F)	150S2 GPM (L/m)	180A2/S2 GPM (L/m)	210A2/S2 GPM (L/m)	240A2/S2 GPM (L/m)
35	6.8 (26)	8.4 (32)	10.1 (38)	11.2 (42)
40	5.9 (22)	7.4 (28)	8.8 (33)	9.8 (37)
45	5.3 (20)	6.5 (25)	7.8 (30)	8.7 (33)
50	4.8 (18)	5.9 (22)	7.1 (27)	7.8 (30)
55	4.3 (16)	5.3 (20)	6.4 (24)	7.1 (27)
60	4.0 (15)	4.9 (19)	5.9 (22)	6.5 (25)
65	3.7 (14)	4.5 (17)	5.4 (20)	6.0 (23)
70	3.4 (13)	4.2 (16)	5.0 (19)	5.6 (21)
75	3.2 (12)	3.9 (15)	4.7 (18)	5.2 (20)
80	3.0 (11)	3.7 (14)	4.4 (17)	4.9 (19)
85	2.8 (11)	3.5 (13)	4.2 (16)	4.6 (17)
90	2.6 (10)	3.3 (12)	3.9 (15)	4.4 (17)
100	2.4 (9)	2.9 (11)	3.5 (13)	3.9 (15)
110	2.2 (8)	2.7 (10)	3.2 (12)	3.6 (14)
120	2.0 (8)	2.5 (9)	2.9 (11)	3.3 (12)
130	1.8 (7)	2.3 (9)	2.7 (10)	3.0 (11)
140	1.7 (6)	2.1 (8)	2.5 (9)	2.8 (11)

## NPE-2 DHW capacity

Models	Natural gas (BTU/H)	Propane gas (BTU/H)
NPE-150S2	18,000-120,000	18,000-120,000
NPE-180A2/S2	10,000-150,000	10,000-150,000
NPE-210A2/S2	12,000-180,000	12,000-180,000
NPE-240A2/S2	13,300-199,900	13,300-199,900

## NPE-2 operating cost

Navien tankless	179 therms	\$195*
Other tankless	209 therms	\$228*
Standard tank	269 therms	\$293*

\*Based on Energy Guide cost estimates using \$1.09 per therm of natural gas. Cost is in US dollars.

## U.S. Green Building Council LEED Points\*

Water heater	Location	Recirculation
1.5 Points	2 Points	3 Points

## Lower HERS home index score\*

\*Please consult your Energy/LEED consultant.

## NPE-2 warranty

Application		Labor	Parts	Heat exchanger
Residential	Standard or controlled recirculation	1 year	5 years	15 years
	Uncontrolled recirculation	1 year	3 years	5 years
Commercial or Combi*	Standard or controlled recirculation	1 year	5 years	8 years
	Uncontrolled recirculation	1 year	3 years	3 years

\*Combi refers to a combination potable water and space heating application. Water heaters cannot be used in space heating only applications.

For complete details please refer to the full warranty at Navieninc.com.

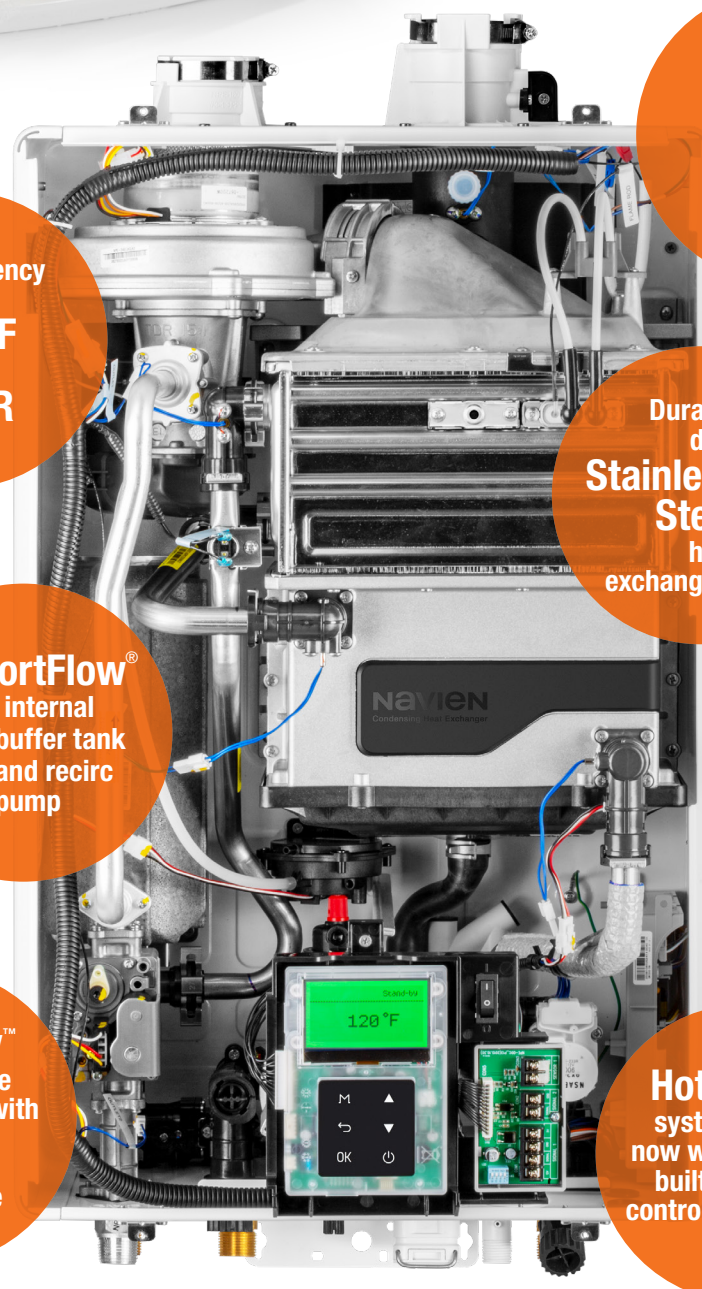

High efficiency up to **0.96 UEF** and up to **15:1 TDR**

2" PVC up to **75 feet** and 1/2" gas up to **24 feet**



Durable dual **Stainless Steel** heat exchangers

Optional **NaviCirc™** Easy to install with no recirc return loop needed



**ComfortFlow®** NPE-A2 internal buffer tank and recirc pump



**EZNav™** multi-line control with built-in intuitive software



Optional **HotButton®** system now with built-in controller



It's **easy** to spot why Navien NPE-2 is the best selling condensing tankless...**again**



# NPE-A2

## NAVIEN PREMIUM EFFICIENCY ADVANCED CONDENSING TANKLESS WATER HEATERS

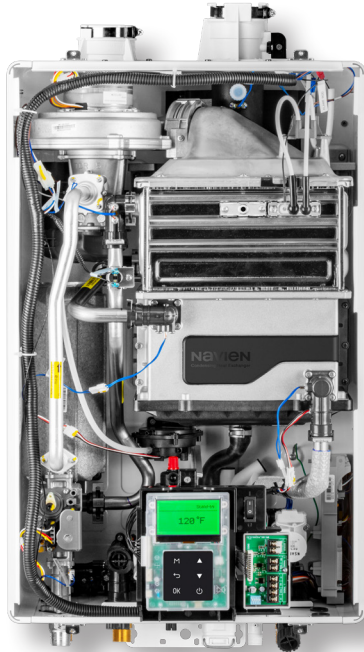

Our advanced ultra high efficiency tankless technology with built in recirc pump, buffer tank and more

### ComfortFlow®

#### NPE-A2 built-in recirculation system

Navien's patented ComfortFlow® system is the first to include a buffer tank, recirculation pump and fine-tuned controls into a tankless water heater, resolving the cold-water sandwich effect\* and issues of minimal flow rates commonly found in other tankless water heaters.

\* The "cold-water sandwich effect" is the undesired introduction of cold water into the hot water supply line on occasions of frequent on/off operations. (Measure Guideline : Transitioning to a Tankless Water heater, DOE, Sept.2012).



### EZNav™

#### Multi-line control with built-in intuitive software

Navien's new backlit EZNav™ control panel uses simple text and icons to make set up, operation status and troubleshooting faster and easier than ever before.



## Naviirc<sup>TM</sup>

### Optional NPE-2 recirculation valve

Designed for recirculation of domestic hot water in applications where a dedicated return line is not available. External pump necessary for NPE-S2 not included.

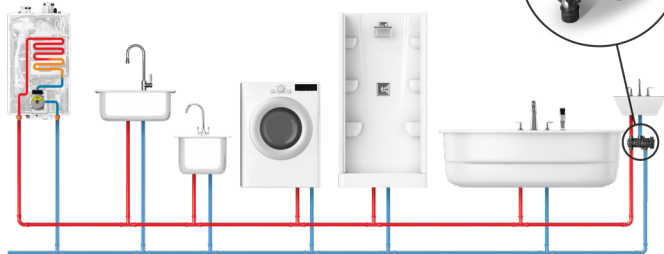

## HotButton<sup>®</sup>

### Optional NPE-2 hot water activation system

At the push of a button, the HotButton<sup>®</sup> hot water system activates internal recirculation pump and gas fired burner to heat water in the supply lines to provide hot water only when needed. NPE-2 comes with a built-in HotButton controller.

External pump necessary for NPE-S2 is not included.

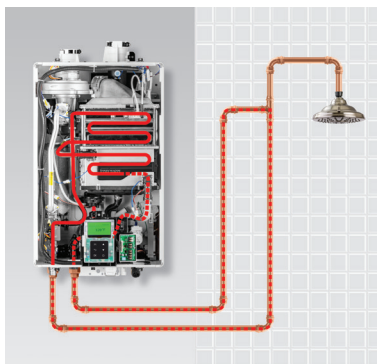

## H2Air<sup>®</sup>

### NPE-A2 combination heating & DHW system

The optional H2Air<sup>®</sup> Kit utilizes the NPE-A2 pump to circulate the hot water for the hydronic air handler.

This removes the need to purchase an additional circulator for the heating system. Designed for retrofit and new construction, the Navien H2Air Kit includes an add-on controller to integrate space heating and DHW between any NPE-A2 Series tankless water heater and a hydronic air handler.

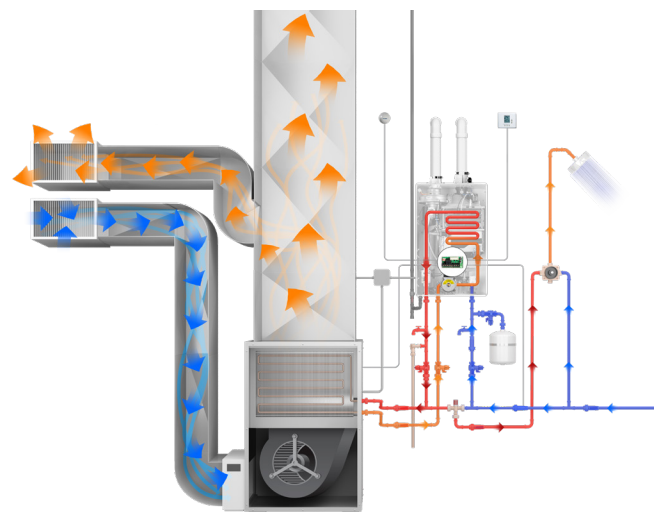

# NPE-S2

## NAVIEN PREMIUM EFFICIENCY STANDARD CONDENSING TANKLESS WATER HEATERS

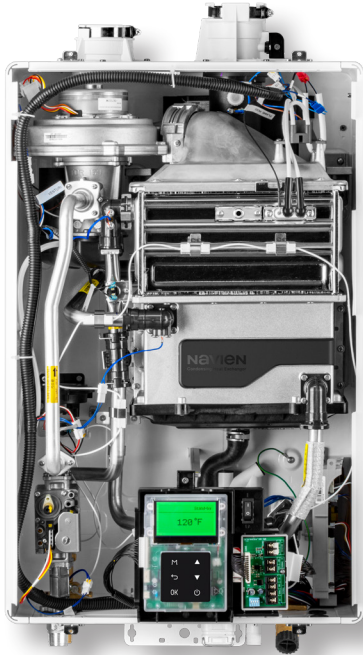

Our standard ultra high efficiency tankless with higher performance and technology

**When it comes to water heater performance... it's all about the output**

The NPE-S2 condensing tankless water heaters are so efficient that they outperform much larger capacity non-condensing competitors. More output for the money, lower installation costs and lower operating costs for customers making it the best choice for your next installation.

**Navien NPE-S2 condensing tankless water heaters outperform comparably priced non-condensing units**

**NON-CONDENSING**

INPUT: 199,000 BTU/h

OUTPUT: ~163,000 BTU/h

**NAVIEN NPE-S2**

INPUT: 180,000 BTU/h

OUTPUT: ~178,000 BTU/h

	Non-Condensing Tankless	Navien NPE-210S2 Condensing Tankless
<b>UNIT SPECS</b>		
Input	199,000 BTU/h	180,000 BTU/h
Uniform Energy Factor (UEF)	~0.81	0.96
Output	~163,000	~178,000
Max GPM	9.8	10.1
List Price	\$\$	\$
<b>INSTALLATION COST</b>		
Installation Time	~4-8 Hours	4 Hours
Venting	Other type (not PVC)	2" PVC
Gas Pipe	Typically 3/4" pipe	Can use existing 1/2" pipe
Overall		<b>Your Choice?</b>



### Cascade up to 32 units and common vent up to 12 units



With Navien cascading technology, when a unit gets up to 80% capacity the next unit will turn on to help meet requirements. This demand ratio will continue until all 32 units are generating hot water. The Navien cascading system also balances out the workload of each unit for longer life. Building penetrations are reduced with Navien's common venting feature.



More innovative accessories for NPE-2 tankless water heaters

# NaviLink® & NaviLink Lite™

## Optional Wi-Fi remote control system



These add-on accessories will enable customers with smartphones and tablets to control temperatures remotely, access usage data and receive diagnostic notifications on all Navien NPE-A2 and NPE-S2 tankless water heaters. NaviLink can support up to 24 Navien units and NaviLink Lite can support 1 Navien unit.



# Ready-Link®

## Modular manifold mounting on wall or rack

- Simply no waiting for custom racks
- Simply easy to install, easy to assemble
- Simply more profitable
- Simply visit your local Navien wholesaler and pick up everything you need for your installation today.

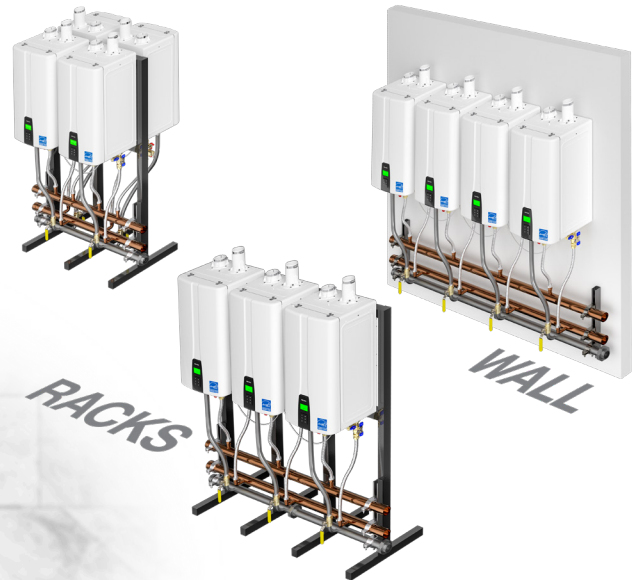

# Dimensions

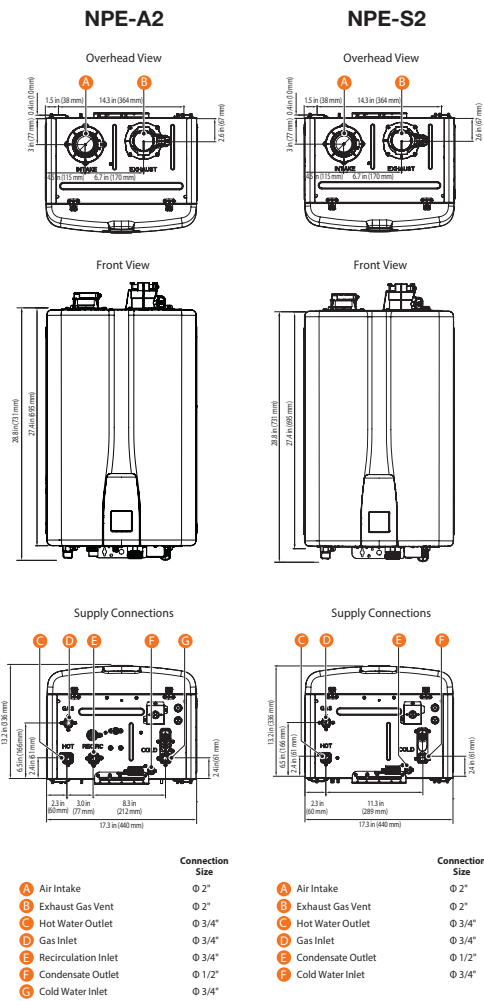

# Specifications

Item	NPE-150S2	NPE-180A2	NPE-180S2	NPE-210A2	NPE-210S2	NPE-240A2	NPE-240S2
Heat capacity (input)	Natural gas 18,000–120,000 BTU/H	10,000–150,000 BTU/H		12,000–180,000 BTU/H		13,300–199,900 BTU/H	
Energy factor	UEF (for NG & LP) 0.93	0.95	0.96	0.95	0.96	0.95	0.96
Flow rate (DHW)	35°F (19°C) temp rise	6.8 GPM (26 L/m)		10.1 GPM (38 L/m)		11.2 GPM (42 L/m)	
	45°F (25°C) temp rise	5.3 GPM (20 L/m)		7.8 GPM (30 L/m)		8.7 GPM (33 L/m)	
	67°F (36°C) temp rise	3.4 GPM (13 L/m)	4.3 GPM (16 L/m)	4.4 GPM (17 L/m)	5.1 GPM (19 L/m)	5.3 GPM (20 L/m)	5.6 GPM (21 L/m)
Dimensions	17.3" (W) x 27.4" (H) x 13.2" (D)						
Weight	62 lbs (28 kg)	73 lbs (33 kg)	68 lbs (31 kg)	77 lbs (35 kg)	73 lbs (33 kg)	77 lbs (35 kg)	73 lbs (33 kg)
Installation type	Indoor or outdoor wall-hung						
Venting type	Forced draft direct-vent						
Ignition	Electronic ignition						
Water pressure	15–150 PSI						
Natural gas supply pressure (from source)	3.5" WC–10.5" WC						
Propane gas supply pressure (from source)	8" WC–13" WC						
Natural gas manifold pressure (min-max)	-0.04" WC– -0.40" WC	-0.03" WC– -0.55" WC		-0.03" WC– -0.76" WC		-0.03" WC– -0.96" WC	
Propane gas manifold pressure (min-max)	-0.03" WC– -0.40" WC	-0.02" WC– -0.55" WC		-0.02" WC– -0.76" WC		-0.02" WC– -0.96" WC	
Minimum flow rate	0.5 GPM (1.9 L/m), < 0.01 GPM (0.04 L/m) option for "A2" models*						
Connection sizes	Cold water inlet	3/4" NPT					
	Hot water outlet	3/4" NPT					
	Gas inlet	3/4" NPT					
Power supply	Main supply	120V AC, 60 Hz					
	Maximum power consumption	200 W (max 2 A), 350 W (max 4 A) with external pump connected					
Materials	Casing	Cold rolled carbon steel					
	Heat exchangers	Primary heat exchanger: stainless steel Secondary heat exchanger: stainless steel					
Venting	Exhaust	2" or 3" PVC, CPVC, approved polypropylene and stainless steel 2" or 3" special gas vent type BH (Class II, A/B/C)					
	Intake	2" or 3" PVC, CPVC, approved polypropylene and stainless steel 2" or 3" special gas vent type BH (Class II, A/B/C)					
	Vent clearances	0" to combustibles					
High elevations	10,100 feet for both NG or LP gas. Please refer to Installation Manual for additional details and instructions.						
Safety devices	Flame rod, APS, ignition operation detector, water temperature high limit switch, exhaust temperature high limit sensor, power surge fuse, burner high limit fuse, vent installation detector (VID)						

\*Available for "A2" models configured in an optional ComfortFlow® recirculation mode. Energy consumption will increase when the system is configured for recirculation. Navien reserves the right to change specifications at any time without prior notice. Please refer to [www.Navieninc.com](http://www.Navieninc.com) to verify you have the most current information.



# Accessories

<b>NaviLink Lite Wi-Fi Control</b> 1 unit PBCM-AS-002	<b>Commercial Replacement Media</b> GXXX001329	<b>2" and 3" Wall Flange and Vent Terminator Kit</b> 2" Kit 30010747A 3" Kit 30003873B	<b>PeakFlow S Scale Prevention System</b> GPWC110001AC001	<b>Common Vent Collar Kit</b> 30014367B	<b>Cascade Cable</b> GXXX000546	<b>NaviCirc Kit</b> 30022965A	<b>Push Button</b> GXX001426	<b>Residential Replacement Media</b> GXXX001323
<b>Light Commercial Neutralizer</b> GXXX001324	<b>Commercial Replacement Media</b> GXXX001325	<b>PeakFlow A</b> GPWC310001AC001	<b>PeakFlow C</b> GPWC510001AC001	<b>Includes Cascade Cable</b> GXXX000546	<b>Use with Isolation Valves</b> 30012581A	<b>Use with Isolation Valves</b> 30012581A	<b>Use with Isolation Valves</b> 30012581A	<b>Add-on (V3)</b> GFFMKDIZUS-006

Navien Inc., 20 Goodyear, Irvine, CA 92618 800-519-8794 [navieninc.com](http://navieninc.com)

Navien Canada, Inc., 555 Hanlan Rd., Unit 7 Vaughan, ON L4L 4R8 800-519-8794 [navieninc.ca](http://navieninc.ca)



THE LEADER IN CONDENSING TECHNOLOGY